

# **ROADEO EVENTS LAYOUTS & DIAGRAMS**

**(January 8, 2018)**

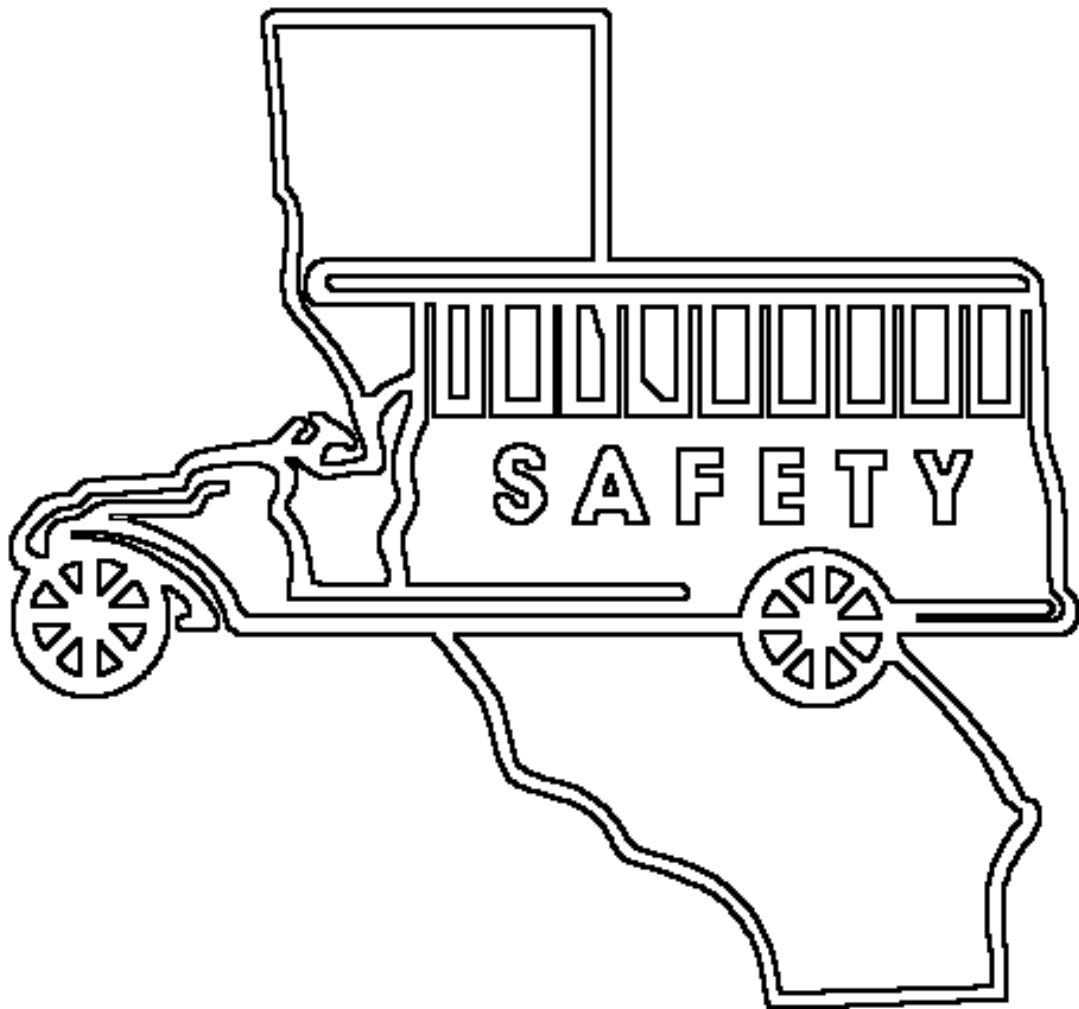

*The Roadeo Events Layout book was developed as a guide to assist in the set-up of Roadeo events for practice and/or competition.*

*It is recommended that you read and understand the Official Roadeo Book. Understanding the Official Roadeo Book will help when actually setting up an event.*

*Should there be any discrepancy or contradiction with this book and the Official Roadeo book, the Official Roadeo book will prevail.*



## **Table of Contents**

STOP LINE DOUBLE CROSSOVER	3
STOP RIGHT TURN	5
LEFT TURN	9
OFFSET ALLEY	11
PARALLEL PARKING	14
BACK UP STALL	16
ELEMENTARY STUDENT LOADING ESCORT	19
ELEMENTARY STUDENT LOADING WHEELCHAIR ESCORT	21
HOW TO MEASURE	23
BARRIERS AND EQUIPMENT	24

# STOP LINE DOUBLE CROSSOVER

## STOP LINE DOUBLE CROSSOVER LAYOUT

### TOOLS AND SUPPLIES NEEDED:

120' rope  
9' rope  
Hammer  
20 cement nails  
Measuring tape

90 degree angle  
One 8' barrier

### DIRECTIONS

1) Lay out, stretch, and  
secure 120 ft. rope "A".

2) L  
a  
y  
  
o  
u  
t

, stretch, and secure 9 ft. rope line “B” at end of approach on rope “A”. Rope must be placed at 90 degree angle on side that competition bus will start and finish.

- 3) Mark for length of competition buses for rear barrier placement. Remember 3 times the length for buses over 29 feet in length and 4 times the length for buses 29 feet, or less, in length.

*Example:* A 30 ft. bus would have a marking at a point 90 ft. from where rope “A” and rope “B” intersect. Place the mark along rope “A” so that a barrier can be placed there after the competition bus has entered the event.

26'	=	104'
25'	=	100'
24'	=	96'
23'	=	92'
22'	=	88'
21'	=	84'
20'	=	80'
19'	=	76'
18'	=	72'
17'	=	68'

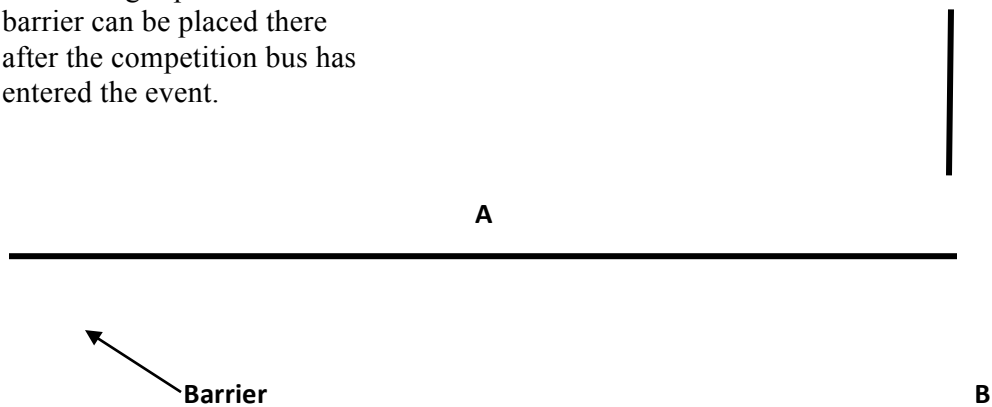

**LENGTH      MARKING**

**3x the length**

40'	=	120'
39'	=	117'
38'	=	114'
37'	=	111'
36'	=	108'
35'	=	105'
34'	=	102'
33'	=	99'
32'	=	96'
31'	=	93'
30'	=	90'

**4x the length**

29'	=	116'
28'	=	112'
27'	=	108'

**STOP  
RIGHT  
TURN**

# STOP RIGHT TURN LAYOUT

## TOOLS AND SUPPLIES NEEDED:

50' Rope (Curb Line 'A')  
15' Rope (Limit Line)  
Two scoring templates  
One stop sign  
One Stick of Crayon/Chalk  
2 Dozen Masonry Nails and Hammer  
90 Degree Right Angle (Carpenter Square)  
100 Foot Measuring Tape  
25 Foot Measuring Tape  
String

## **DIRECTIONS**

Pull and tie strings on each line as indicated on chart.

Distances are shown in feet to each intersecting line.

Check with rodeo chairperson for radius of turn.

1. Lay out 50' curb line rope 'A' on the approach to the turn.
2. Lay out 31' string line 'B' at 90 degree angle from end of 50' curb line 'A' (See Chart).
3. Lay out 15' foot limit line rope on line 'B' starting from curb line 'A'.
4. Set approach scoring template 2' from, and parallel to, curb line 'A' with end of template 4' from limit line 'B' (See Chart).
5. Lay out predetermined radius length string line 'C' parallel to, and 4' from, string line 'B' (line should be no less than 30' long) . String line 'C' should begin at location 'X' which is at the back right corner of the approach scoring template (See Chart).
6. Lay out 30' string line 'D' at 90 degree angle from string line 'C'. Line 'D' should begin on line 'C' 14 feet from the curb line 'A' (See Chart).

7. Lay out 40' string line 'E' at ninety degree angle from string line 'C'. Line 'E' should begin on line 'C' at a point matching the predetermined radius (See Chart).
8. Recovery scoring template should be placed along and at a 90 degree angle to line 'E' and at the predetermined radius as established by the roadeo chairperson. Beginning at the right back corner of the approach scoring template (X on chart) measure on string line 'C' to the predetermined radius (string line 'E') and then measure the same predetermined radius along string line 'E' to the free zone entry corner of the recovery scoring template.

*Example:* If the radius is 32 feet, then measure 32 feet from the back right corner of the approach template (X on chart) down string line 'C' and set a nail on string line 'C' at the 32' mark (predetermined radius). From this nail start string line 'E' at 90 degree angle to string line 'C' and measure 32' (predetermined radius) from line 'C'. This is the point where the free zone entry corner of the recovery scoring template should be placed. The template should be placed at a 90 degree right angle to string line 'E' (See Chart).

9. Place left side of barrier at a 90 degree right angle to string line 'E' with left side 2 feet before the recovery scoring template (predetermined radius minus 2 feet) and the left rear corner 3 feet to the left of string line 'E' (See Chart). **Barrier should never hinder the vehicle from successfully making the turn, only from seeing the template while at the limit line.**
10. Remove all string lines.
11. Set up stop sign at limit line just inside curb line 'A'.
12. Place right turn sign 100 feet prior to limit line on the approach.



# Stop Right Turn Layout Chart

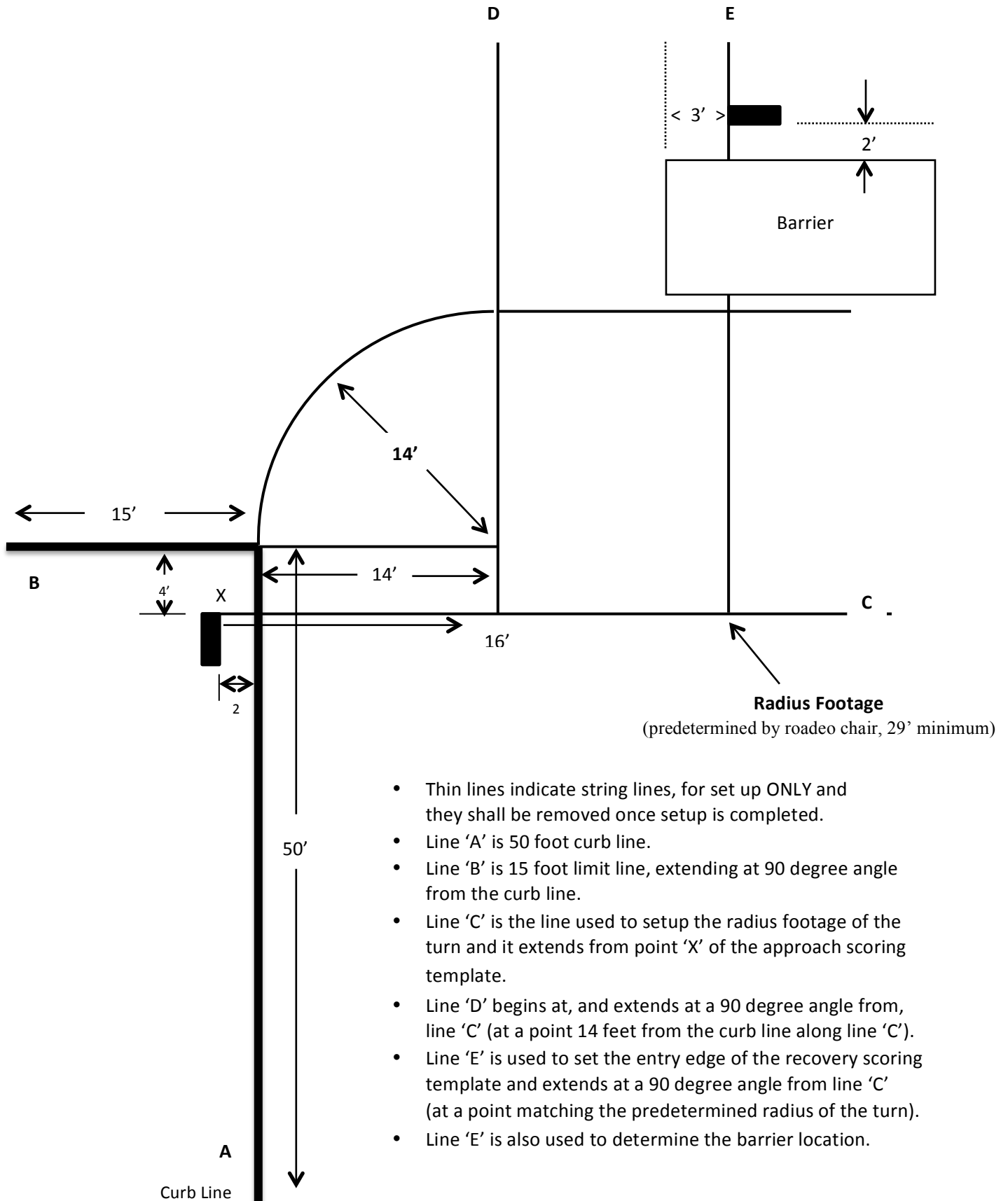

- Thin lines indicate string lines, for set up ONLY and they shall be removed once setup is completed.
- Line 'A' is 50 foot curb line.
- Line 'B' is 15 foot limit line, extending at 90 degree angle from the curb line.
- Line 'C' is the line used to setup the radius footage of the turn and it extends from point 'X' of the approach scoring template.
- Line 'D' begins at, and extends at a 90 degree angle from, line 'C' (at a point 14 feet from the curb line along line 'C').
- Line 'E' is used to set the entry edge of the recovery scoring template and extends at a 90 degree angle from line 'C' (at a point matching the predetermined radius of the turn).
- Line 'E' is also used to determine the barrier location.

**LEFT  
TURN**

# LEFT TURN LAYOUT

## TOOLS and SUPPLIES NEEDED:

50' Rope  
Hammer  
Cement Nails  
100' Tape Measure  
90 degree angle  
String

## DIRECTIONS

1. Layout 50' curb line "A".
2. Layout 45' string line "B" at a 90 degree angle with line "A", line "B" should also stretch 7' on the template side from line "A".
3. Place approach template on line "B", 3' from line "A".
4. Get the turn radius from the roadeo chairperson.
5. Measure along line "B" from left back corner of approach template (X on chart) the radius footage determined by the chairperson. Set a nail at that spot.
6. Layout 45' string line "C" at a 90 degree angle from line "B", starting at the nail set at the determined radius along line "B".
7. Measure from line "B" along line "C", the radius footage plus 3'.
8. Place the left front corner of the return template at the appropriate mark on line "C".
9. Remove string line "B" & "C" and the nails that held them.
10. Place "LEFT TURN" sign 150' prior to the approach template.

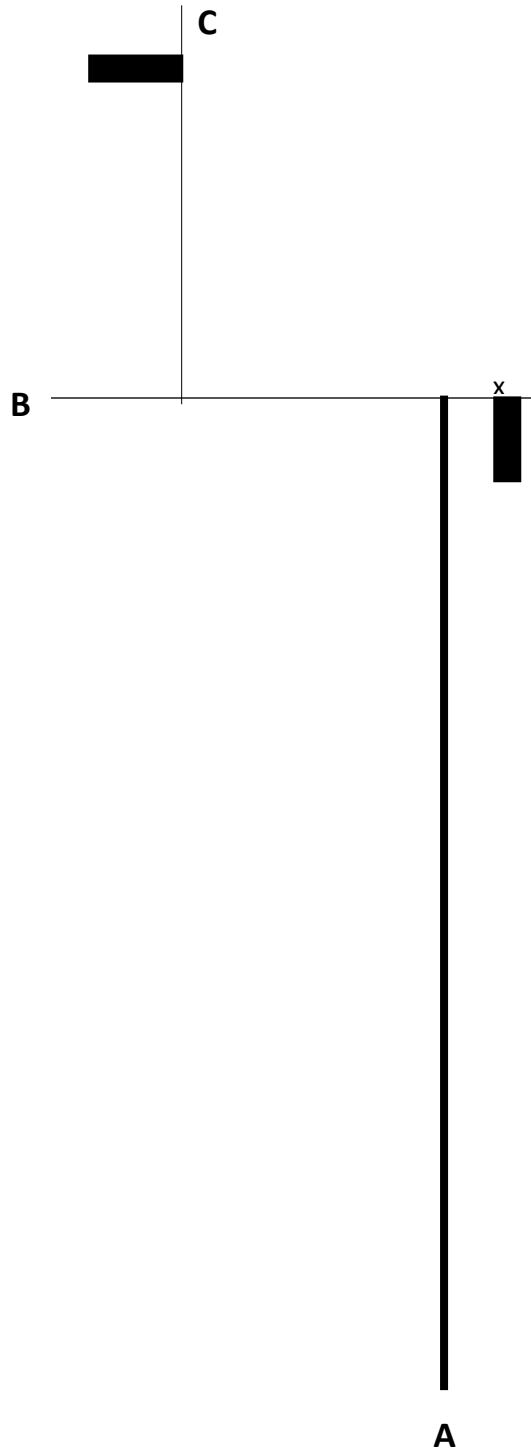

# **OFFSET ALLEY**

# OFFSET ALLEY LAYOUT

## **TOOLS and SUPPLIES NEEDED:**

6 Barriers with Flag Tips  
12 Bases – 8 w/side wheels, 4 w/out wheels  
120' String  
Hammer  
100ft. Measuring Tape  
25ft. Measuring Tape  
White or Yellow Crayon/Chalk

## **DIRECTIONS**

It takes some experience to learn to setup this event. Always try to have someone available who has helped set up this event before.

Start Offset Alley set up with the center barriers and work from there.

Stretch and nail 120' string (Line A) to use as reference.

Place far end of center barrier 65' from beginning of Line A.

Determine direction of Offset.

For Center Barrier

1. Measure 15 inches off center of string and place one end barrier on base w/no wheels at that point.
2. Measure 15 inches off center of string and place other end of the barrier on base w/no wheels.
3. Mark bases with Crayon/Chalk.
4. Measure 12 ½' from the base of the barrier leg towards the direction of the offset. Place one end barrier on base w/no wheels at that point.
5. Measure 12 ½' from the base of the other barrier leg towards the direction of the offset. Place one end barrier on base w/no wheels at that point.
6. Measure from flag tip to flag tip, Should be 10 feet between flag tips. Surface of pavement may cause distances to be off, adjust barrier farthest from string, until flag tips are 10 feet apart
7. Square barriers by measuring from the first flag retaining nut on the end nearest the beginning end of the first barrier diagonally across to the last flag retaining nut of the far end of the second barrier. Note measurement.
8. Now, measure from the third flag retaining nut on the far end of the first barrier diagonally across to the first flag retaining nut on the end nearest the beginning end of the second barrier. This should be the exact same measurement as noted from the previous measurement.
9. If measurements are not the same, move barrier farthest from string left or right until measurements are the same.
10. Re-measure flag tip to flag tip to make sure they are still at 10 feet apart.
11. When measurements are correct. Mark bases with Crayon/Chalk.

For End Barrier

1. Measure along string 43 feet from one end of center barrier, put mark at that point.
2. Measure 15 inches off string on the opposite side of the string from the offset.
3. Place one end barrier on base w/ wheels at that point.
4. Moving away from center barrier measure 15 inches off string on the side of the string of the offset.
5. Place other end of barrier on base w/ wheels at that point.
6. Measure 12 ½' from the base of the barrier leg opposite the offset. Place one end barrier on base w/wheels at that point.
7. Measure 12 ½' from the base of the other barrier leg and place other end of barrier on base w/wheels at that point.
8. Measure from flag tip to flag tip, Should be 10 feet between flag tips. Surface of pavement may cause distances to be off, adjust barrier farthest from string, until flag tips are 10 feet apart

9. Square barriers by measuring from the first flag retaining nut on the end nearest center of the first barrier diagonally across to the third flag retaining nut of the of the far end of the second barrier. Note measurement.

10. Now, measure from the third flag retaining nut of the far end of the first barrier diagonally across to the first flag retaining nut nearest the center end of the second barrier. This should be the exact same measurement as noted from the previous measurement.
11. If measurements are not the same, move barrier farthest from string left or right until measurements are the same.
12. Re-measure flag tip to flag tip to make sure they are still at 10 feet apart.
13. When measurements are correct. Mark bases with Crayon/Chalk.

Do other end the exact same way. When all six barriers are set. Stretch and nail string from end barrier to end barrier and mark every 1 foot going towards center barrier. This will give you marks for different bus lengths. **Please note that beginning in 2018 the setup for all vans will allow for the vehicle length plus 3 feet, while all other vehicles 29 feet and under in length will continue to be allowed the vehicle length plus only 2 feet.**

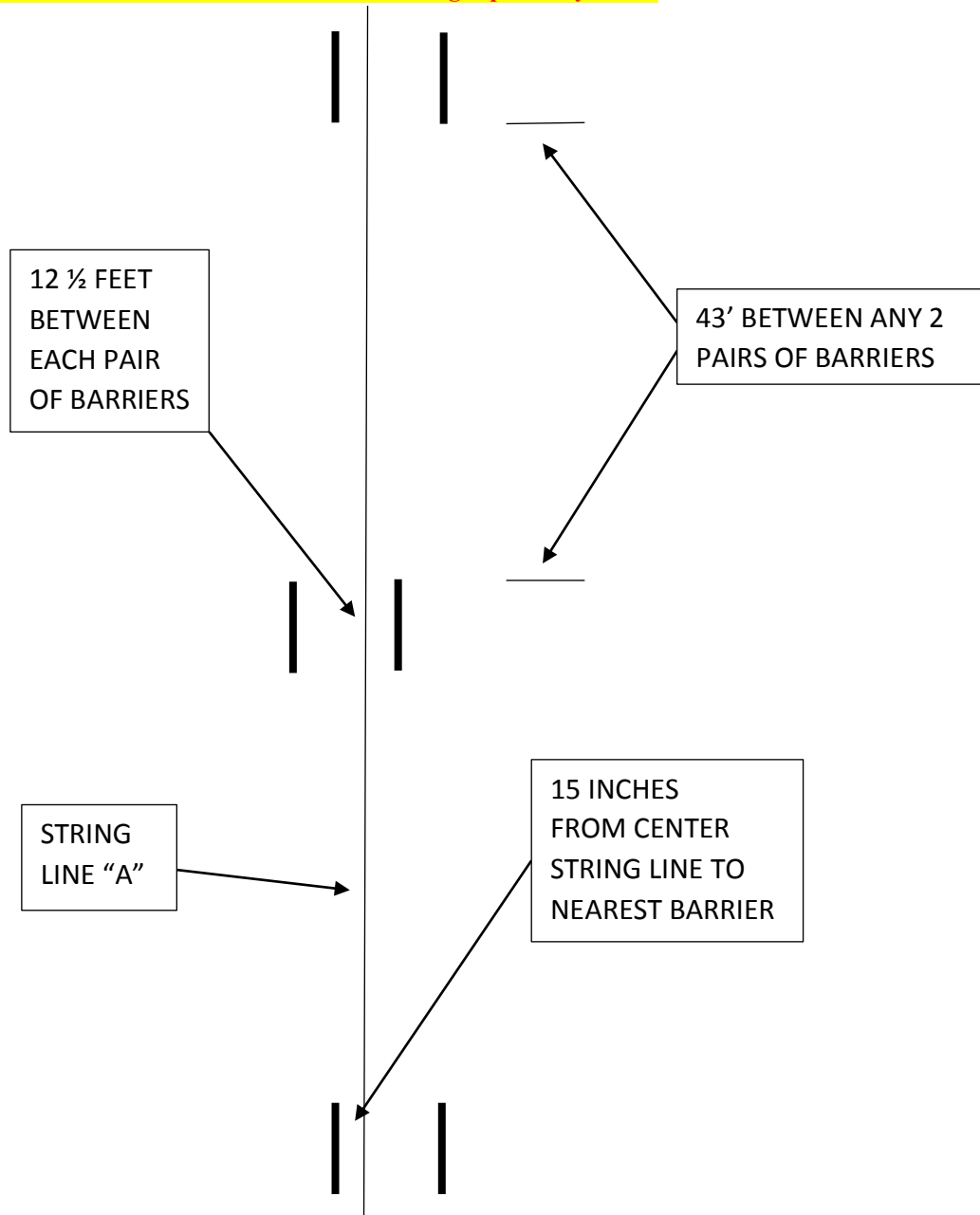

# **PARALLEL PARKING**

# PARALLEL PARKING LAYOUT

## TOOLS and SUPPLIES NEEDED:

50' Rope  
Two 8' Barriers  
Chalk / Crayon  
Measuring Device  
Chalk line  
Hammer  
Cement Nails  
50' Tape Measure

## DIRECTIONS

1. Layout 50' rope line "A".
2. Set stationary 8 ft. barrier "C" (bases w/no wheels) at 90 degree angle to line "A".
3. End of upright barrier MUST be on the rope line.
4. Snap chalk line "D", 8 ft. and parallel to line "A"
5. Measure and mark along line "A" and line "D" the appropriate bus lengths

Settings for bus lengths:

Transit Bus	length plus 6'
Vans and van type vehicles	length plus 7'
Conventional Bus	length plus 6'

6. Place barrier "B" (bases w/wheels) at appropriate bus lengths

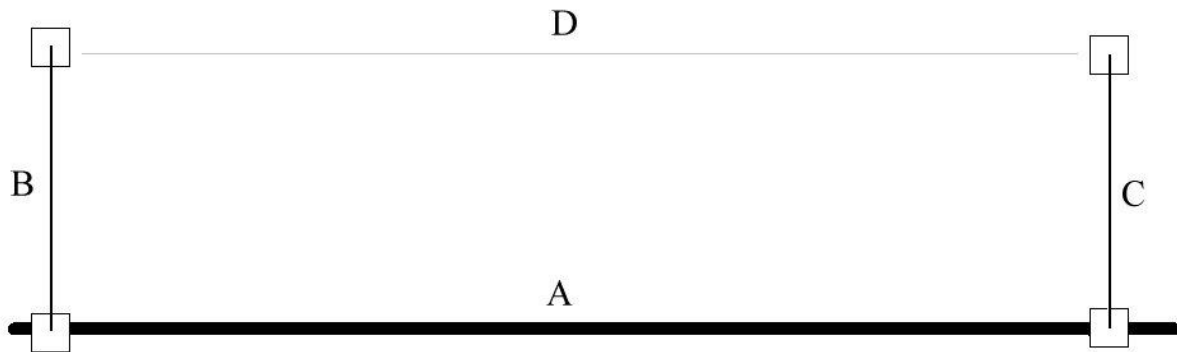



# **BACKUP STALL**

## **BACKUP STALL LAYOUT**

### **TOOLS and SUPPLIES NEEDED:**

Backup Stall Poles  
Backup Stall Barriers/Flags  
2 lengths 120 ft. rope  
25 ft. rope  
Centerline string  
100 ft. tape measure  
Hammer and Cement Nails  
Road Chalk/Crayon  
3" Wide Tape for score zone

### **DIRECTIONS**

1. Using 120ft. ropes, stretch out and nail down lines "A" and "B" parallel and 10ft. apart (8ft. apart for vans and narrow vehicles) from each other. Length of the lines "A" and "B", indicating the depth of the stall, will be determined by rodeo chairperson. The rear of lines "A" and "B" SHOULD NOT be the same distance past rear barrier (should be at different lengths).
2. Stretch and nail down centerline "C" string line exactly centered between lines "A" and "B".
3. Stretch and nail down 25 ft. rope line "D", starting 20 ft. from line "C" and 90 degree to lines "B" and "C".
4. Set rear barriers/flags "G" at the rear of the stall centered between lines "A" and "B".
5. Measure 1½ ft. from rear barrier along line "C" and mark or set start of score zone "H".
6. If using a score zone pad, starting at the 1½ ft. mark from rear barrier, rollout and nail down pad along side of line "C". If you do not have a score zone pad, starting at the 1½ ft. mark from rear barrier, measure and mark every 6" along line "C" until you are 10 ft. from barrier. Measure 4ft. from rear barrier and mark rear of FREE ZONE. Measure one additional foot, which will be 5ft. from rear barrier and mark other end of FREE ZONE. Starting from the free zone each 6" section toward the rear barrier will be marked in 10 demerit increments up to 50 and each 6" section going away from the rear barrier and free zone will be marked in 5 demerit increments up to 50.
7. Measure and mark from line "D" along lines "A" and "B" appropriate distance for bus lengths as follows: Transit Buses = Bus Length plus 1', Conventional Buses and Vans = Bus Length plus 4'.
8. Set poles/barrier "E" and "F" at appropriate bus length for bus on lines "A" and "B". Move poles "E" and "F" as necessary.

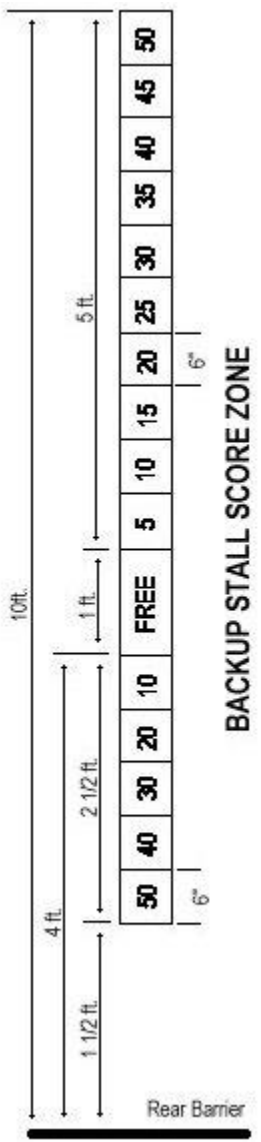
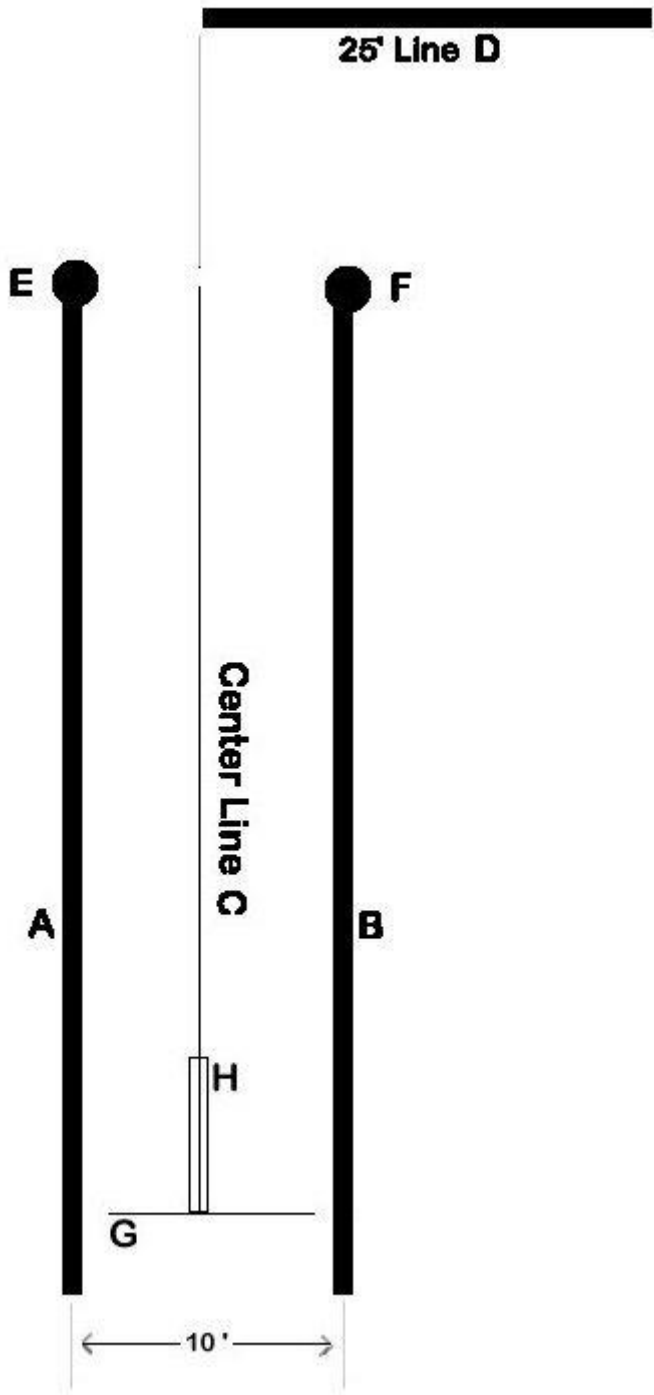

**ELEMENTARY  
STUDENT  
LOADING  
ESCORT**

# ELEMENTARY STUDENT LOADING ESCORT LAYOUT

## TOOLS and SUPPLIES NEEDED:

Two 8ft. barriers plus bases (2 with and 2 without wheels)  
 100' rope  
 Chalk and Chalk Line  
 100 ft. Measuring tape  
 Hammer  
 Cement nails  
 Measuring Devices

## DIRECTIONS

1. Lay 100ft. rope line "A". This will represent a curb line
2. Measure and mark a 8ft. line "B" and "C" at both ends of line "A" at a 90 degree angle to line "A".
3. Mark with a chalk line a line "D" between the end of line "B" and "C", 8ft. and parallel to line "A".
4. Mark with crayon or chalk where barrier bases are to be placed.
5. Place barriers on line "B" (bases w/no wheels) and "C" (bases w/wheels). These represent the obstacles at either end of the event, this is maximum length.
6. Mark the appropriate bus length along the outside of curb line "A" and line "D"
7. Using the following bus size list, mark the appropriate distances on the pavement.

<u>BUS LENGTH</u>	<u>BARRIER PLACEMENT</u>
40'	100'
39'	97 ½'
38'	95'
37'	92 ½'
36'	90'
35'	87 ½'
34'	85'
33'	82 ½'
32'	80'
31'	77 ½'
30'	75'
29'	72 ½'
28'	70'
27'	67 ½'
26'	65'
25'	62 ½'
24'	60'
23'	57 ½'
22'	55'
21'	52 ½'
20'	50'
19'	47 ½'
18'	45'
17'	42 ½'

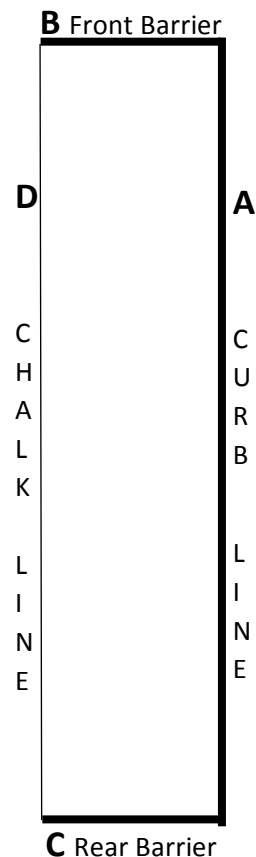

**ELEMENTARY  
STUDENT  
LOADING  
WHEELCHAIR  
ESCORT**

# ELEMENTARY STUDENT LOADING WHEELCHAIR ESCORT LAYOUT

## TOOLS and SUPPLIES NEEDED

1 8' barrier with bases  
100' Rope  
1 Lift Scoring Template  
Crayon or Chalk  
Tape Measure  
Measuring Device  
Hammer & Nails

## DIRECTIONS

1. Start with one completed Student Loading Escort event.
2. Measure 50' along rope starting from front barrier and mark location.
3. This represents the center line of the Lift Scoring Template at a 90 degree angle to the rope.
4. Measure the predetermined depth to the right of the rope and mark location.
5. This represents the center line of the Lift Scoring Template laterally from the rope.
6. The center line depth is determined by the Rodeo Chairperson and shall be between the range of 18" minimum and 54" maximum.
7. Place the Lift Scoring Template so that the cross hair marked locations on the ground run through the center of the free zone and the left edge is parallel to the rope.
8. Nail the Lift Scoring Template down at all four corners.
9. When a Special Needs contestant is ready to enter the event remove the rear 8' barrier and leave the front 8' barrier in place.

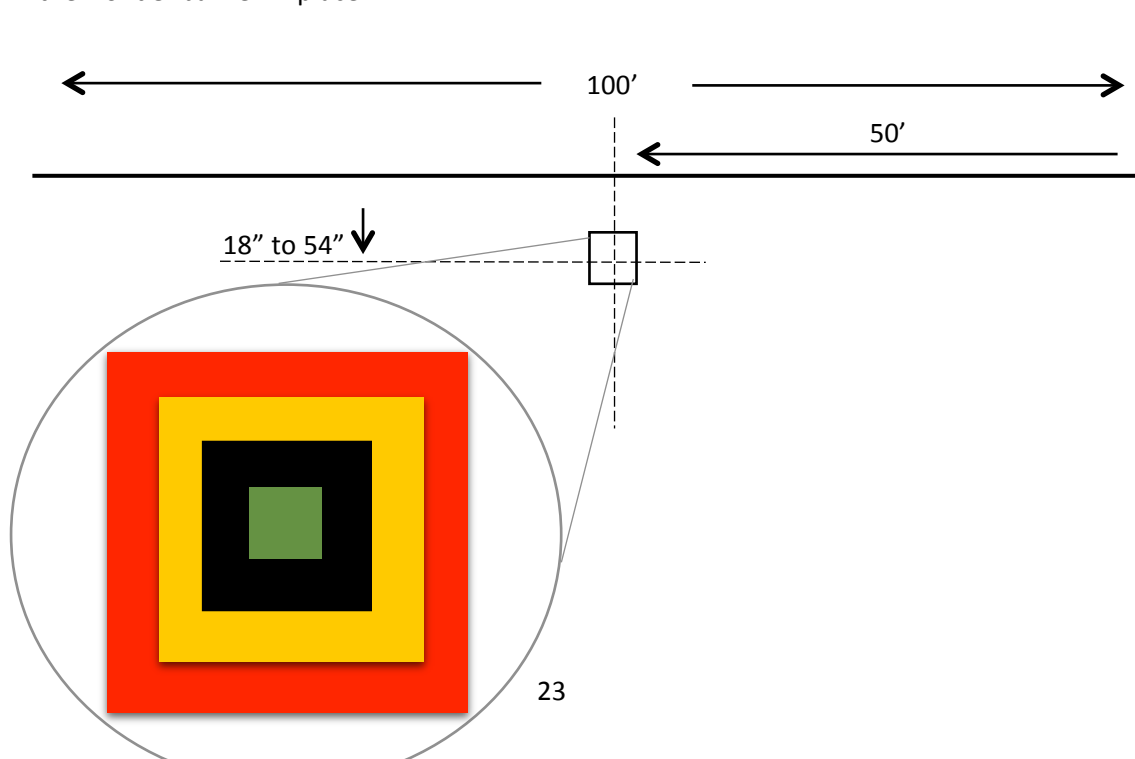

## Bus Measuring Instructions and Diagram

For the purpose of measuring a bus during an event, the following diagrams will be of assistance:

### WHERE TO MEASURE:

#### For All Transit Style Buses

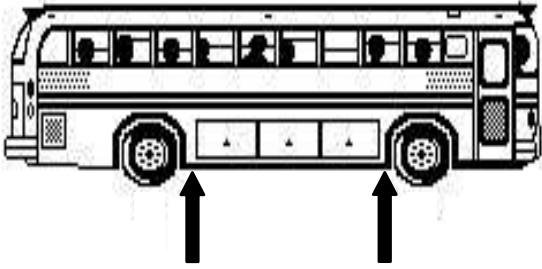

The Position Of The Plane, Both Front And Rear, In Relation To The Curb

#### For All Conventional Style Buses

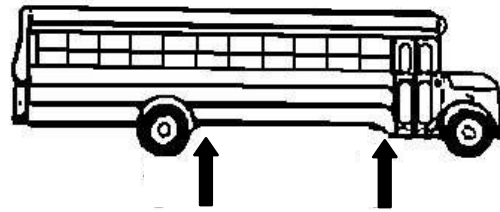

The Position Of The Plane and The Widest Point Of The Body, just Behind The Entrance Door In relation To The Curb

#### For All Wide Body Vans

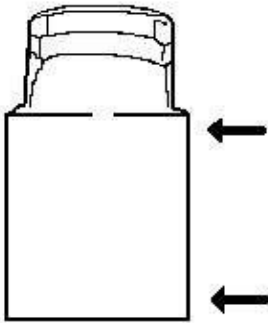

The Widest Part Of The Body, Both Front And Rear, In Relation To The Curb

#### For All Other Vans

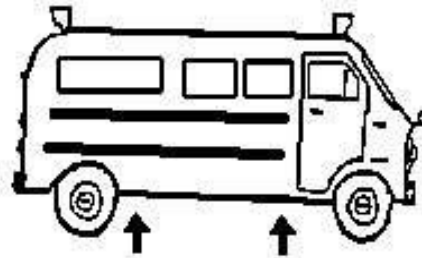

The Widest Part Of The Body, Both Front And Rear, In Relation To The Curb

### AT THE BODY:

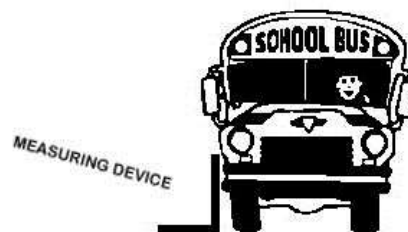



**BARRIERS  
and  
EQUIPMENT**

**DESIGN  
and  
DIMENSIONS**

For rodeo setup you will need various equipment. The following is a guideline on equipment needed and dimensions of equipment.

List of minimum equipment needed:

- 700 ft  $\frac{3}{4}$  inch yellow twisted poly rope
- 250 ft #18 yellow nylon twine
- 5 8ft barriers
- 6 10ft barriers with extending tips
- 2 4ft. tall stanchions
- 2 Back-up flags
- 26 bases
- 1 Stop Sign
- 4 Turn plates

Barriers are made of 1 inch square tubing.

Base is  $\frac{1}{4}$  inch steel plate with 1  $\frac{1}{4}$  inch square tubing attached.

*Practice Equipment can be constructed with 2 inch PVC pipe, following the same dimensions. It is lighter in weight but less sturdy. It is recommended that you DO NOT glue PVC pipe together (in case some one runs over it in practice and cracks the pipe), so it will easier to fix broken parts later.*

Barrier Base:

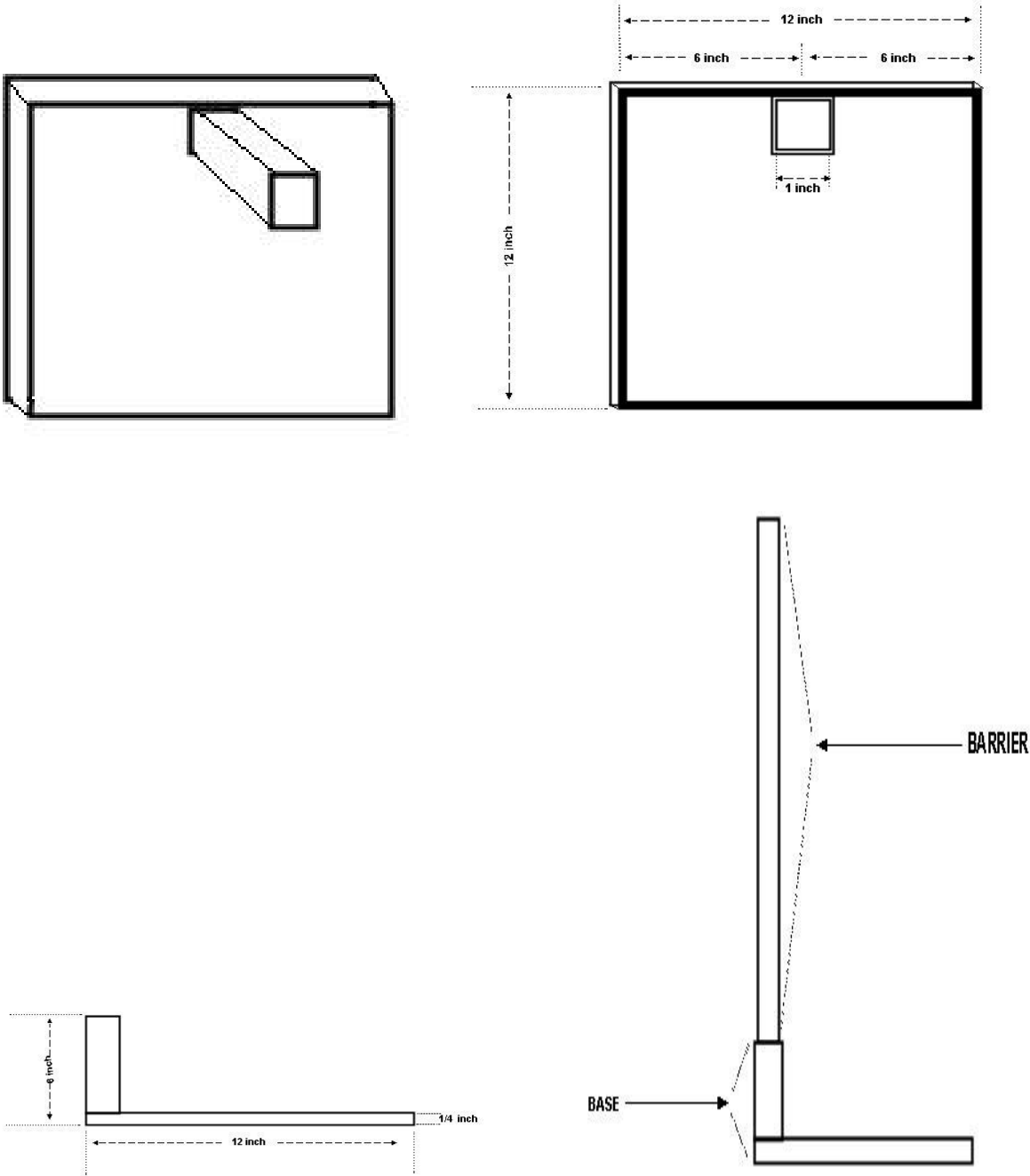

BARRIERS:

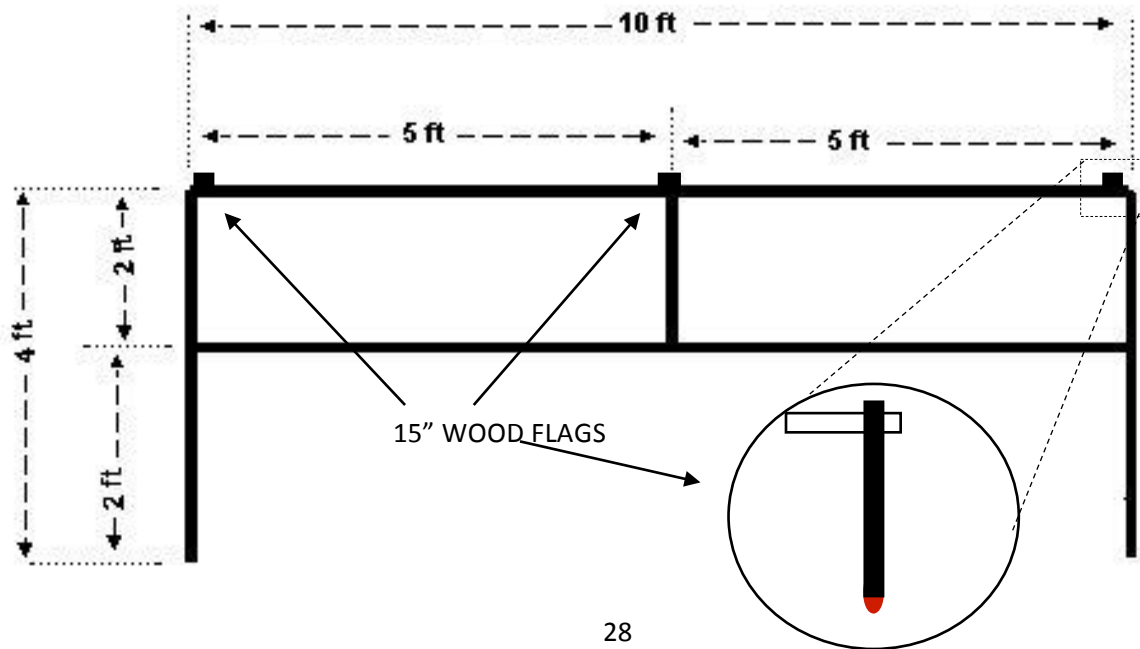
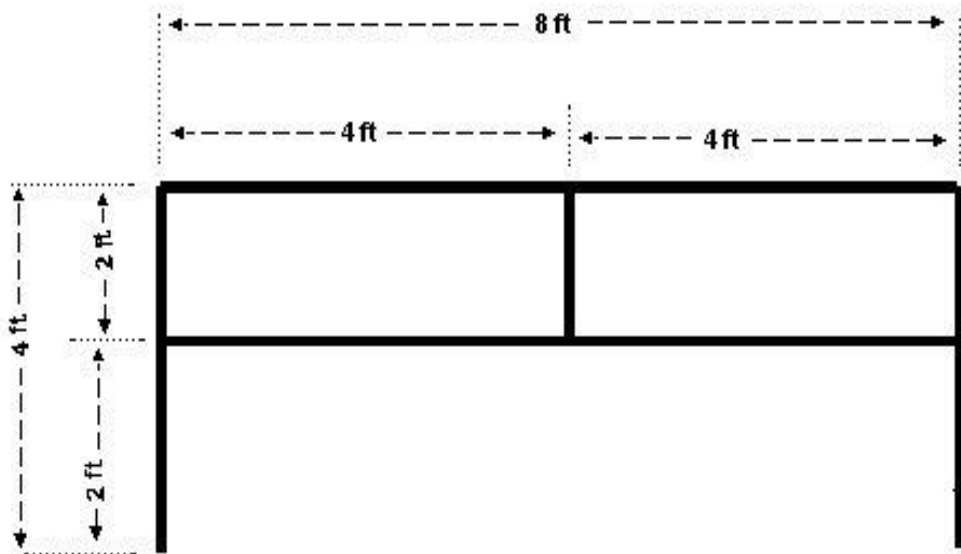
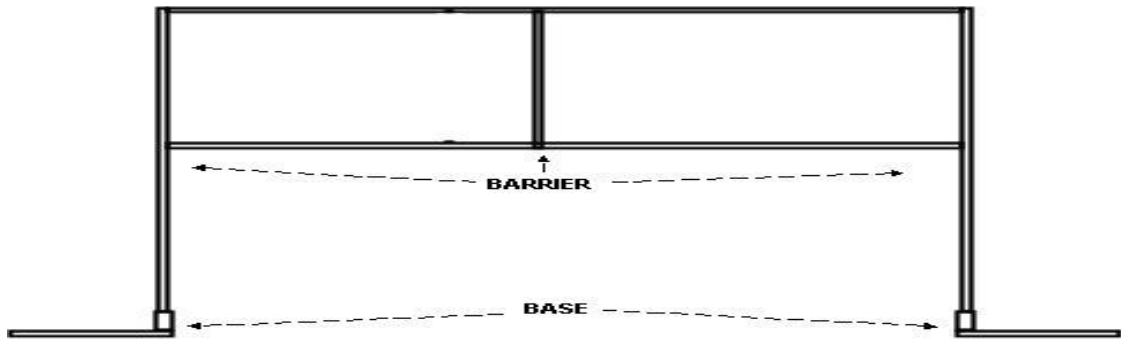

# BACK-UP STALL FLAGS AND STANCHIONS

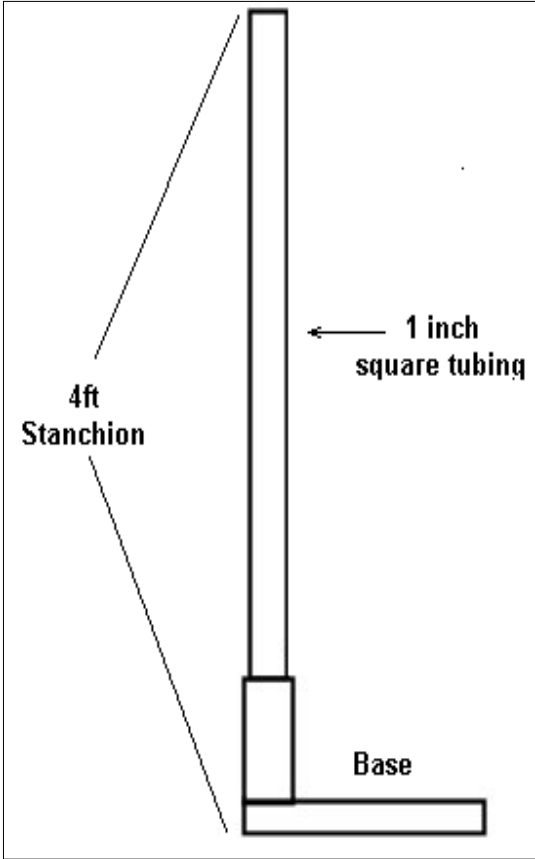
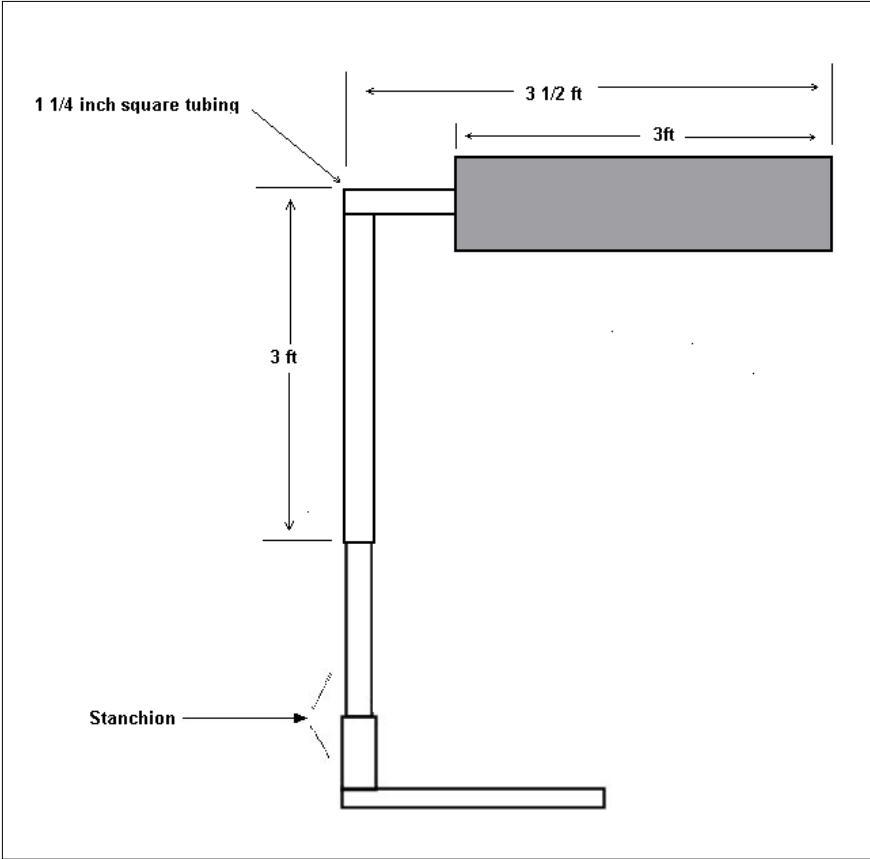

# TURN SCORE PADS

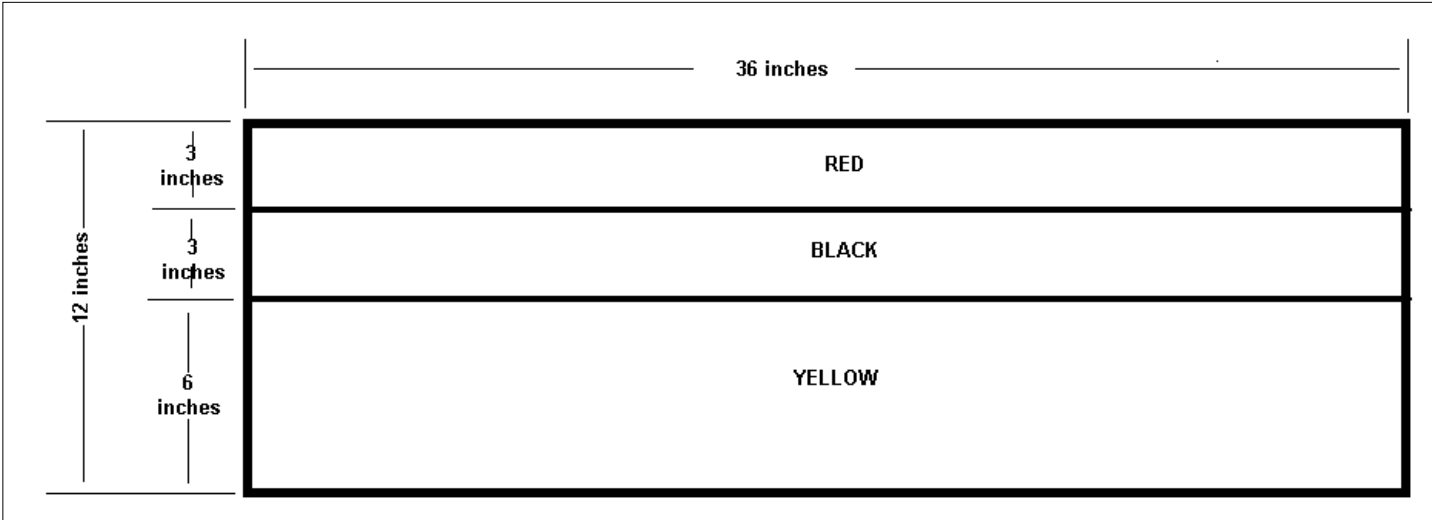

# WHEELCHAIR LIFT TEMPLATE

